

Dell PowerVault MD3260/3260i/3660i/3660f/3060e Storage Arrays Getting Started Guide

Regulatory Model: E08J Series
Regulatory Type: E08J001



Notes, Cautions, and Warnings



NOTE: A NOTE indicates important information that helps you make better use of your computer.



CAUTION: A CAUTION indicates either potential damage to hardware or loss of data and tells you how to avoid the problem.



WARNING: A WARNING indicates a potential for property damage, personal injury, or death.

© 2013 Dell Inc. All Rights Reserved.

Trademarks used in this text: Dell™, the Dell logo, Dell Boomi™, Dell Precision™, OptiPlex™, Latitude™, PowerEdge™, PowerVault™, PowerConnect™, OpenManage™, EqualLogic™, Compellent™, KACE™, FlexAddress™, Force10™, Venue™ and Vostro™ are trademarks of Dell Inc. Intel®, Pentium®, Xeon®, Core® and Celeron® are registered trademarks of Intel Corporation in the U.S. and other countries. AMD® is a registered trademark and AMD Opteron™, AMD Phenom™ and AMD Sempron™ are trademarks of Advanced Micro Devices, Inc. Microsoft®, Windows®, Windows Server®, Internet Explorer®, MS-DOS®, Windows Vista® and Active Directory® are either trademarks or registered trademarks of Microsoft Corporation in the United States and/or other countries. Red Hat® and Red Hat® Enterprise Linux® are registered trademarks of Red Hat, Inc. in the United States and/or other countries. Novell® and SUSE® are registered trademarks of Novell Inc. in the United States and other countries. Oracle® is a registered trademark of Oracle Corporation and/or its affiliates. Citrix®, Xen®, XenServer® and XenMotion® are either registered trademarks or trademarks of Citrix Systems, Inc. in the United States and/or other countries. VMware®, vMotion®, vCenter®, vCenter SRM™ and vSphere® are registered trademarks or trademarks of VMware, Inc. in the United States or other countries. IBM® is a registered trademark of International Business Machines Corporation.

2013 - 09

Rev. A02

Installation and Configuration

 **WARNING:** Before performing the following procedure, review the safety instructions that came with the system.

Unpacking A Rack System

 **WARNING:** The weight of your system without the physical disks installed (empty weight) is 19.50 kg (43.0 lb) and when fully populated with all the physical disks is 105.20 kg (232.0 lb).

 **WARNING:** Your system must be installed by Dell certified service technicians. For safe installation of an empty system, a minimum of three service technicians are required. To install a fully populated system, a mechanized lifting tool is required to position the system in a rack.

 **WARNING:** Install the physical disks into the system only after installing the system in the rack. Installing the system in the rack with the physical disks installed can damage the disks or cause injury.

 **CAUTION:** Before installing your system in the rack, ensure that the weight of the system does not exceed the rack's weight limit. For more information, see the Rack Installation Instructions that shipped with your system.

 **NOTE:** For weight stability, always load the rack from the bottom up.

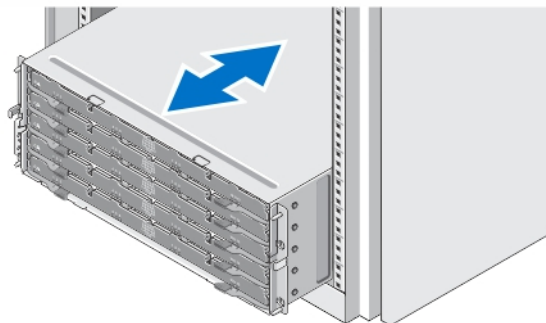

Figure 1. Installing the System in a Rack

Unpack your system and identify each item.

Assemble the rails and install the system in the rack following the safety instructions and the rack installation instructions provided with your system.

Opening And Closing The Disk Drawer

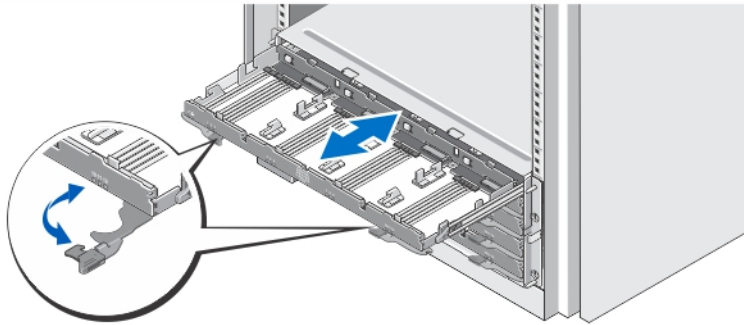

Figure 2. Opening and Closing the Disk Drawer

Open the disk drawer to install or remove the physical disk carrier(s).

- NOTE: You can open only one disk drawer at a time. Forcing to open more than one drawer at a time may damage the assembly or produce unexpected results.

Installing The Physical Disks

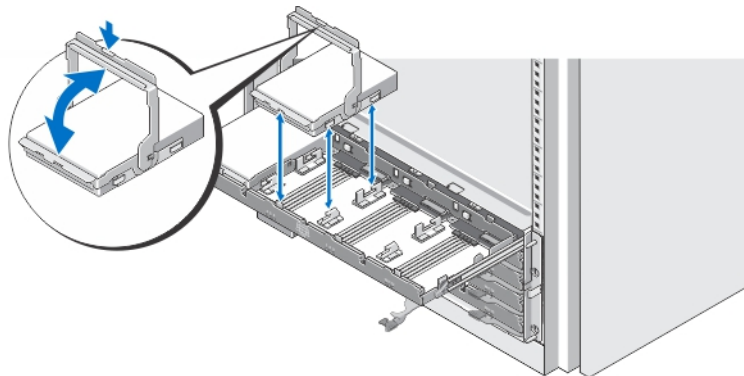

Figure 3. Installing the Physical Disk(s)

Install physical disk(s) in the disk drawer.

- NOTE: You may receive multiple drives with carriers in separate boxes. Drives need to be installed in the same enclosure.
- NOTE: Each disk drawer must have a minimum of four physical disks installed starting from slots 0, 3, 6, and 9. Always install the physical disks starting from the front row of each drawer.
- NOTE: Ensure all drawers are firmly closed using the handles.

Connecting The Power Cable(s)

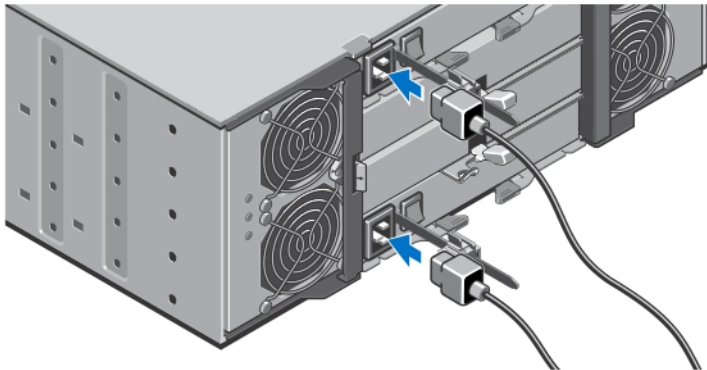

Figure 4. Connecting the Power Cable(s)

Connect the system's power cable(s) to the system.

Securing The Power Cable(s)

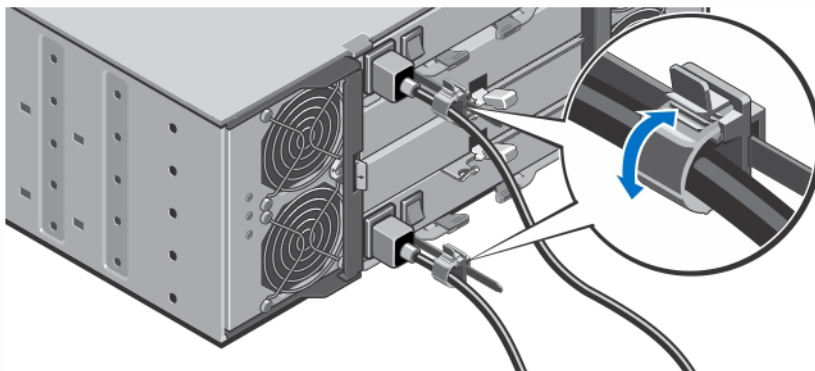

Figure 5. Securing the Power Cable(s)

Open the cable retention bracket by pulling the tabs on its sides, insert the cable, and secure the system power cable, as shown in the illustration.

Plug the other end of the power cable(s) into a grounded electrical outlet or a separate power source such as an uninterruptible power supply (UPS) or a power distribution unit (PDU).

Turning On The System

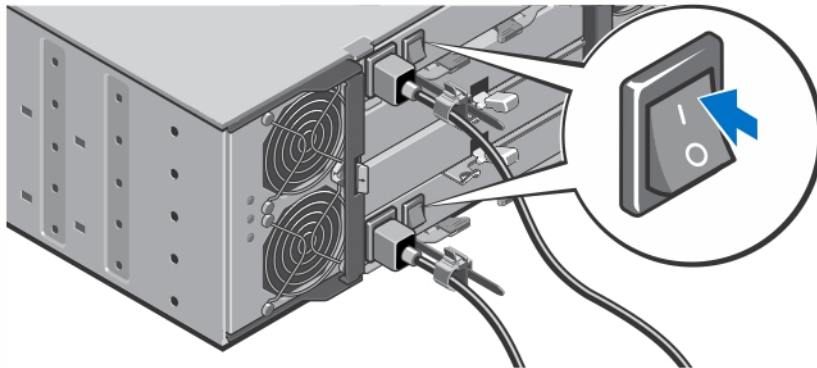

Figure 6. Turning on the System

Turn the power switch on the back of the system to the On position. The power LED will turn on.

Installing The Bezel

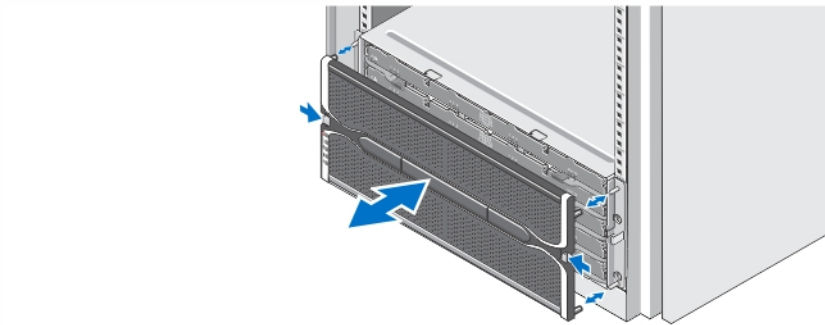

Figure 7. Installing the Bezel

Install the bezel as shown in the figure.

Dell Software License Agreement

Before using your system, read the Dell Software License Agreement that came with your system. You must consider any media of Dell-installed software as BACKUP copies of the software installed on your system's hard drive. If you do not accept the terms of the agreement, call the customer assistance telephone number. For customers in the United States, call 800-WWW-DELL (800-999-3355). For customers outside the United States, see dell.com/support and select your country or region from the top left of the page.

Other Information You May Need



WARNING: See the safety and regulatory information that shipped with your system. Warranty information may be included within this document or as a separate document.

- The *Owner's Manual* provides information about system hardware features and describes how to troubleshoot the system and install or replace system components. This document is available online at dell.com/support/manuals.
- The *Administrator's Guide* provides information about **Modular Disk Storage Manager** software features and describes how to configure and manage your modular disk system. This document is available online at dell.com/support/manuals.
- The *Deployment Guide* provides information about cabling your system and the installation and initial configuration of the **Modular Disk Storage Manager** software. This document is available online at dell.com/support/manuals.
- For videos and other resources on PowerVault MD series, see dell.com/PVresources.
- The rack documentation included with your rack solution describes how to install your system into a rack, if required.
- Any media that ships with your system that provides documentation and tools for configuring and managing your system, including those pertaining to the operating system, system management software, system updates, and system components that you purchased with your system.



NOTE: Always check for updates on dell.com/support/manuals and read the updates first because they often supersede information in other documents.



NOTE: When upgrading your system, it is recommended that you download and install the systems management firmware on your system from dell.com/support.

Obtaining Technical Assistance

If you do not understand a procedure in this guide or if the system does not perform as expected, see your system Owner's Manual. Dell offers comprehensive hardware training and certification. See dell.com/training for more information. This service may not be offered in all locations.

Technical Specifications



NOTE: The following specifications are only those required by law to ship with your system. For a complete and current listing of the specifications for your system, go to dell.com/support.

Power

AC power supply (per power supply)

Wattage	1,755 W
Heat dissipation (maximum)	5988 BTU/hr



NOTE: Heat dissipation is calculated using the power supply wattage rating. The heat dissipation values are for the entire system which includes chassis and two controllers.

Voltage	220 V AC, autoranging, 50 Hz/60 Hz
---------	------------------------------------

Power

 **NOTE:** This system is also designed to be connected to IT power systems with a phase to phase voltage not exceeding 230 V.

Battery 6.6 V DC, 1100 mAh, 7.26 W Lithium Ion Battery

Physical

Height 177.80 mm (7.0 inch)
Width 482.60 mm (19.0 inch) with rack latches
Depth 825.50 mm (32.5 inch) without bezel and handle
Weight (maximum configuration) 105.20 kg (232.0 lb)
Weight (empty) 19.50 kg (43.0 lb)

Environmental

 **NOTE:** For additional information about environmental measurements for specific system configurations, see dell.com/environmental_datasheets.

Temperature

Maximum Temperature Gradient (Operating and Storage) 20 °C/hour (36 °F/hour)
Storage Temperature Limits -40 °C to 65 °C (-40 °F to 149 °F)

Temperature (Continuous Operation)

Temperature Ranges (for altitude less than 950 m or 3117 ft) 10 °C to 35 °C (50 °F to 95 °F) with no direct sunlight on the equipment

 **NOTE:** For information on supported expanded operating temperature range and configurations, see the *Owner's Manual* dell.com/support/manuals.

Humidity Percentage Range 10% to 80% Relative Humidity with 26 °C (78.8 °F) maximum dew point.

Relative humidity

Storage 5% to 95% RH with 33 °C (91 °F) maximum dew point. Atmosphere must be non-condensing at all times

Maximum vibration

Operating 0.26 G_{rms} at 5 Hz to 350 Hz in operational orientation
Storage 1.88 G_{rms} at 10 Hz to 500 Hz for 15 minutes (all six sides tested)

Maximum shock

Operating One shock pulse in the positive z axis (one pulse on each side of the system) of 31 G for 2.6 m in the operational orientation.

Environmental

Storage Six consecutively executed shock pulses in the positive and negative x, y, and z axes (one pulse on each side of the system) of 71 G for up to 2 m.

Altitude

Operating –30.5 m to 3048 m (–50 to 10,000 ft).

 **NOTE:** For altitudes above 2950 ft, the maximum operating temperature is derated 1.8 °F/1000 ft.

Storage Up to 12,000 m (39,370 ft).

Operating Altitude De-rating Up to 35 °C (95 °F) maximum temperature is reduced by 1 °C/300 m (1 °F/547 ft) above 950 m (3,117 ft)
35 °C to 40 °C (95 °F to 104 °F) maximum temperature is reduced by 1 °C/175 m (1 °F/319 ft) above 950 m (3,117 ft)
40 °C to 45 °C (104 °F to 113 °F) maximum temperature is reduced by 1 °C/125 m (1 °F/228 ft) above 950 m (3,117 ft)

Particulate Contamination

 **NOTE:** This section defines the limits to help avoid IT equipment damage and/or failure from particulates and gaseous contamination. If it is determined that levels of particulates or gaseous pollution are beyond the limits specified below and are the reason for the damage and/or failures to your equipment it may be necessary for you to remediate the environmental conditions that are causing the damage and/or failures. Remediation of environmental conditions will be the responsibility of the customer.

Air Filtration Data center air filtration as defined by ISO Class 8 per ISO 14644-1 with a 95% upper confidence limit.

 **NOTE:** Applies to data center environments only. Air filtration requirements do not apply to IT equipment designed to be used outside a data center, in environments such as an office or factory floor.

 **NOTE:** Air entering the data center must have MERV11 or MERV13 filtration.

Conductive Dust Air must be free of conductive dust, zinc whiskers, or other conductive particles.

 **NOTE:** Applies to data center and non-data center environments.

Corrosive Dust

 **NOTE:** Applies to data center and non-data center environments.

- Air must be free of corrosive dust.
- Residual dust present in the air must have a deliquescent point less than 60% relative humidity.

Gaseous Contamination

 **NOTE:** Maximum corrosive contaminant levels measured at ≤50% relative humidity

Copper Coupon Corrosion Rate <300 Å/month per Class G1 as defined by ANSI/ISA71.04-1985.

Silver Coupon Corrosion Rate <200 Å/month as defined by AHSRAE TC9.9.